



The Hawthorne



midwaywindows.com



Windows that Lend Grace and Beauty

The process of selecting new windows involves careful consideration. You need to be confident your new windows will enhance your home's beauty and deliver a lifetime of reliable performance. Alliance Window Systems' Hawthorne series is designed to answer all these needs.

Our "flagship" series, the Hawthorne, marries traditional architectural design with state-of-the-art manufacturing. The result? Windows that endure the test of time in classic style, to lend grace and beauty to your home's décor, season after season, year after year. All Hawthorne models come standard with the Alliance Window Systems' InnovativE® insulating glass package, full Clear-View screens, and the industry's best warranty.

The Hawthorne doesn't stop at beauty and durability. You'll appreciate how easy it is to maintain, clean and operate.

The Hawthorne: A Wise Investment



Double-Hung Windows Keep Your Home Safe and Snug. When the weather outside turns frightful, you can rely on our heavy-walled, multi-chambered, double-hung model to keep you safe from the elements. Hawthorne double-hung windows are rigorously engineered and tested to be weather-tight and energy efficient. The balance system is guaranteed to operate for life.

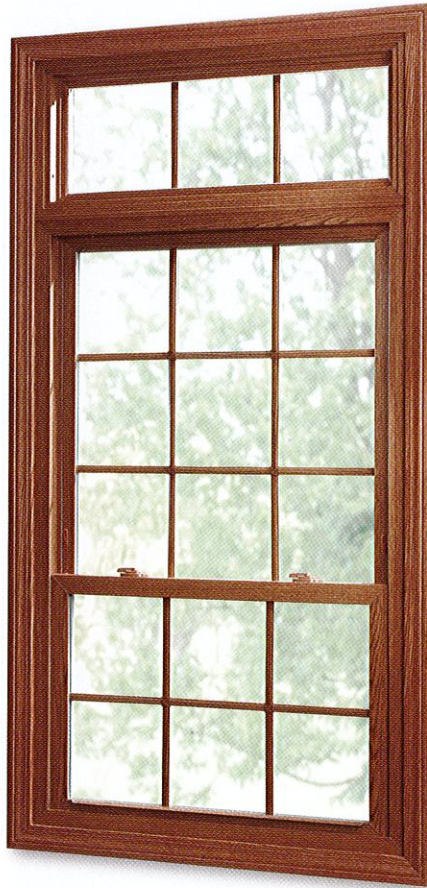

Double-Hung Features

- Double strength glass is standard.
- Three layers of weather stripping is standard on all sashes.
- Balance covers are standard for a finished interior look.
- Non-corrosive hardware includes a lifetime of trouble-free performance.
- Cam lock action draws sashes closer together for positive lock.
- Additional security provided by an interlocking meeting rail.
- Extruded full screen for durability.

Anatomy of Efficiency

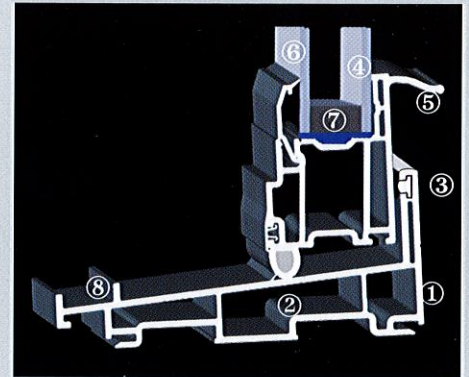

- (1) Heavy walled (0.070") PVC framing acts as a natural insulator
- (2) Closed cell compression seal at sloped sill resists air and water penetration
- (3) Triple-fin seal weather stripping at sill further reduces air infiltration
- (4) 3/4" Insulating glass provides optimum energy efficiency
- (5) Dual hollows at lift rail add strength and insulation
- (6) InnovativE[®] high performance glass utilizes Low E coating specifically engineered for local requirements
- (7) "Warm edge" low conductance spacer resists energy flow through the edge of glass
- (8) Rigid leg on sill prevents "screen rattle" even on windy days

Invite the Light In!



Twin-Vent Slider Features

- Two sets of double-wheeled brass rollers transfer weight of glass directly to frame reducing stress on sash members.
- Rollers glide on integral track system allowing for effortless fingertip operation.
- Both sashes lift out for easy cleaning.
- Independent weep chambers on frame assure effective water run-off.

Casement Features

- Sash opens 90 degrees so windows can be cleaned easily from inside your home.
- All components are corrosion resistant providing years of trouble-free performance.
- Multi-point locking system locks sash at multiple points for utmost security.
- Three layers of weather stripping assure effective barrier to air and water penetration.
- Top rated hardware system allows even the largest casements to be effortlessly and smoothly operated.
- Narrow frame maximizes the exposed glass area.



Bow & Bay Features

- For maximum support and precision, adjustable turn-buckle cable support system is standard.
- Knee brace supports are optional.
- Insulated seatboard (R-9) provides greater resistance to cold and condensation and is available in oak or birch both unfinished and prefinished.
- Weatherproof vinyl capping system for maximum weather protection and minimal maintenance.



Exterior & Interior Colors*

You'll appreciate the many colors available in our Hawthorne series. Customers can choose from 45 standard mix and match combinations available from our exterior color selections, and interior colors and woodgrain finishes. We can also custom match any exterior color!

*Note: Colors and woodgrains shown are printed representations. Contact your local Alliance Window Systems® dealer to view actual samples.

Exterior color options are available on all Alliance Window Systems® products. When grids are ordered, the color will be made to match exterior frame color.

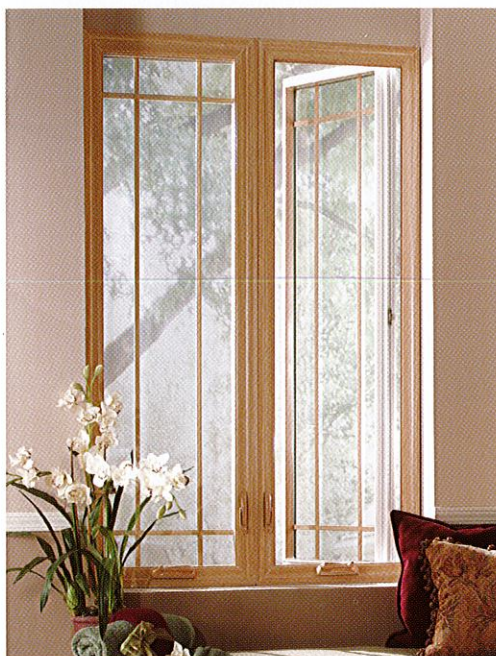

Standard Interior Colors

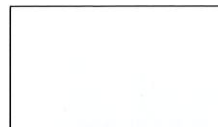

White



Tan

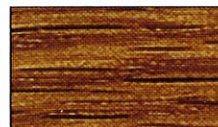

Dark Oak

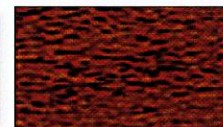

Cherry



Light Oak

Standard Exterior Colors

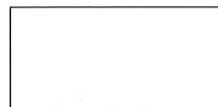

White



Tan



Clay

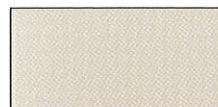

Ivory Cream



Dark Bronze



Terra Bronze



Forest Green



Royal Brown



Black

Casement, slider and double-hung windows are available in three laminated wood grain interiors – Dark Oak, Cherry and Light Oak. (Light Oak is shown.)

Duralite® Warm Edge Spacer

Midway Windows uses only Duralite® spacers which are the best spacers in comparison testing with other commonly used insulated glass systems. Duralite® spacers yield a lower window U-value – up to 0.03 over other less efficient systems. And that means more comfort and energy savings for you.

Condensation Resistance: No spacer system can eliminate condensation, but Duralite® reduces conductivity by 50% over other warm edge spacers. Reducing conductivity also reduces condensation.

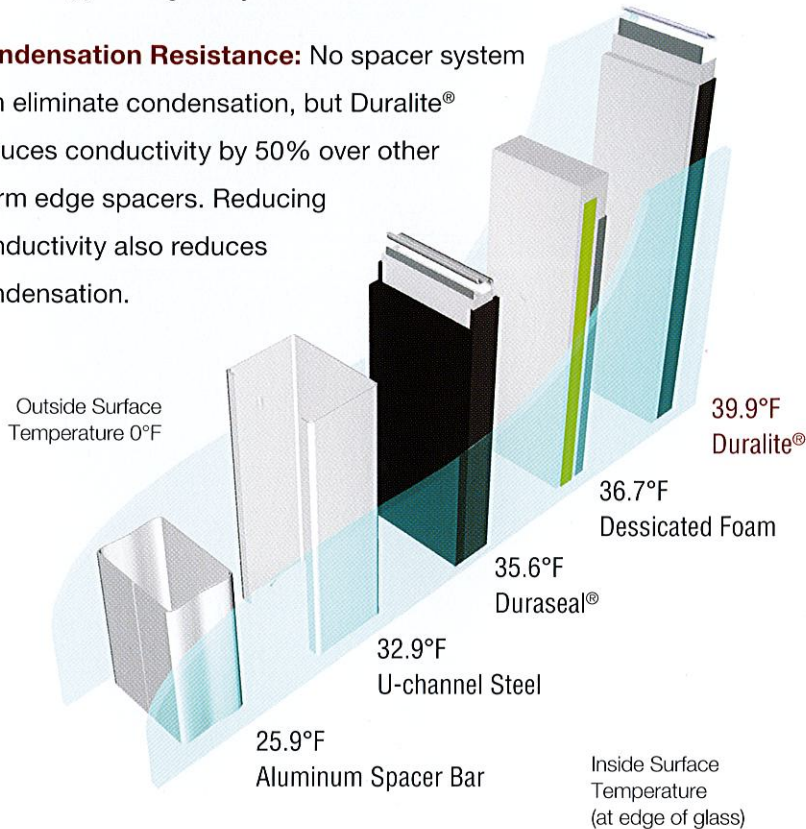

Easy Operation and Cleaning



Window cleaning is simplified with tilt-in upper and lower sashes.

Options

Choices include standard and custom pattern grids in your choice of flat, contour or pencil muntin bars that fit securely within the insulating glass air space.

Other options include upgrade Low E coatings, triple glazing, tinted and obscure glass, choice of nine exterior colors available with white, tan or three woodgrain interior finishes.

Insulating Foam-in-Frame

- Adds rigidity to frame
- Enhances sound-deadening qualities of frame
- Enhances energy efficiency of frame through increased thermal performance
- Foam fills entire cavity to provide complete coverage without voids

Integral Fin

- The Hawthorne family of products is available with an integral fin. This includes Double Hungs, Twin-Vent Sliders, Three-Lite Sliders and Picture Windows.



The Hawthorne: A Remarkable Window

| Product | U Value | Solar Heat Gain Coefficient | Air Infiltration |
|---|---------|-----------------------------|------------------|
| Hawthorne Double-Hung – InnovativE® Glass Package* | 0.27 | 0.28 | 0.12 |
| Hawthorne Casement – InnovativE® Glass Package* | 0.27 | 0.27 | 0.03 |
| Hawthorne Twin-Vent Slider – InnovativE® Glass Package* | 0.27 | 0.28 | 0.09 |

*The InnovativE® Glass Package comes standard with double strength glass, Low E coating, Duralite® spacer and Argon gas fill.



Our Lifetime Warranty

Alliance is not just our name. It also accurately describes our approach to doing business, and it's why we can provide such an exceptional warranty on every window we offer for your consideration. A proud, independent regional fabricator of excellent experience and reputation meticulously crafts each of our windows. By linking these carefully selected and exceptional fabricators into a national network, or alliance, we are able to be so confident of the quality that is designed and built into our windows, we can back our entire product line with an unsurpassed warranty.

Of course, other window companies may also say they offer a warranty, but we urge you to carefully read their fine print. They may, for example, guarantee the vinyl extrusion, but what about all the moving parts or the insulated glass? The Alliance Assurance Plus[®] Limited Lifetime Warranty covers it all – for life! Even more remarkable, if a factory defect needs repair within the first five years, we will even provide the labor required.

Many windows leave you wide open to unpleasant surprises. Select a window from Alliance Window Systems[®] and you'll know it's backed by a warranty second to none.

Visit midwaywindows.com



Look for the ENERGY STAR label on qualified products.